

PERSPECTIVE VIEW

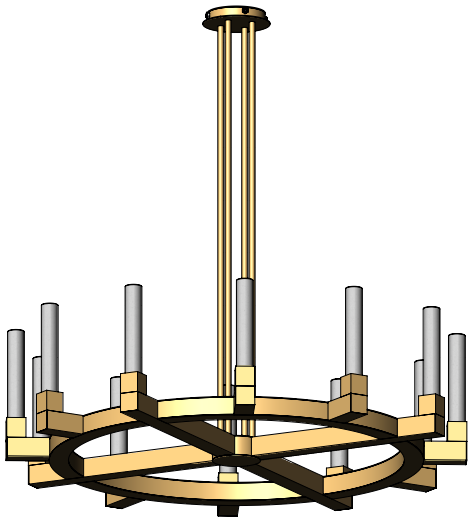

CSTA 0015 CH

Custom Chandelier

WEIGHT:	67 lbs
CANOPY:	Custom
CHAIN:	N/A
Shade	Custom White onyx
NO. LIGHTS:	12
BASE:	Candelabra 2"
FINISH:	Tier 1 gold
DRAWING:	Carlos Quezada

1/13/2022

FRONT VIEW

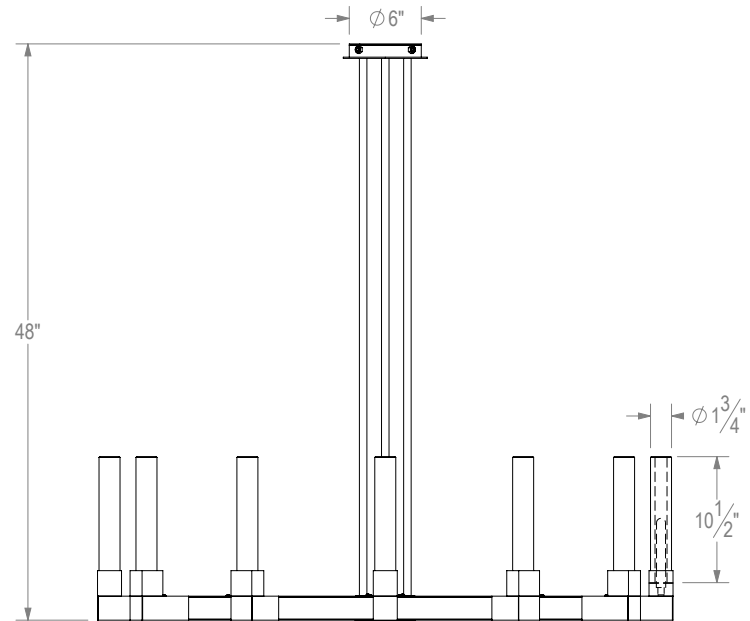

BOTTOM VIEW

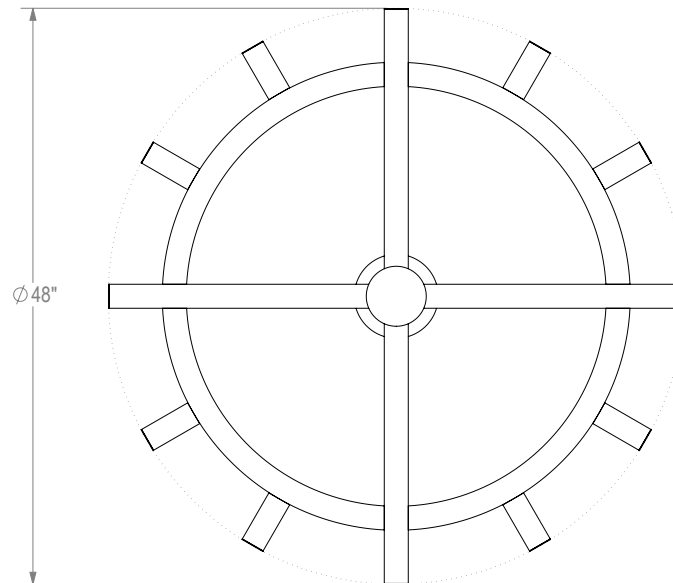

PERSPECTIVE VIEW

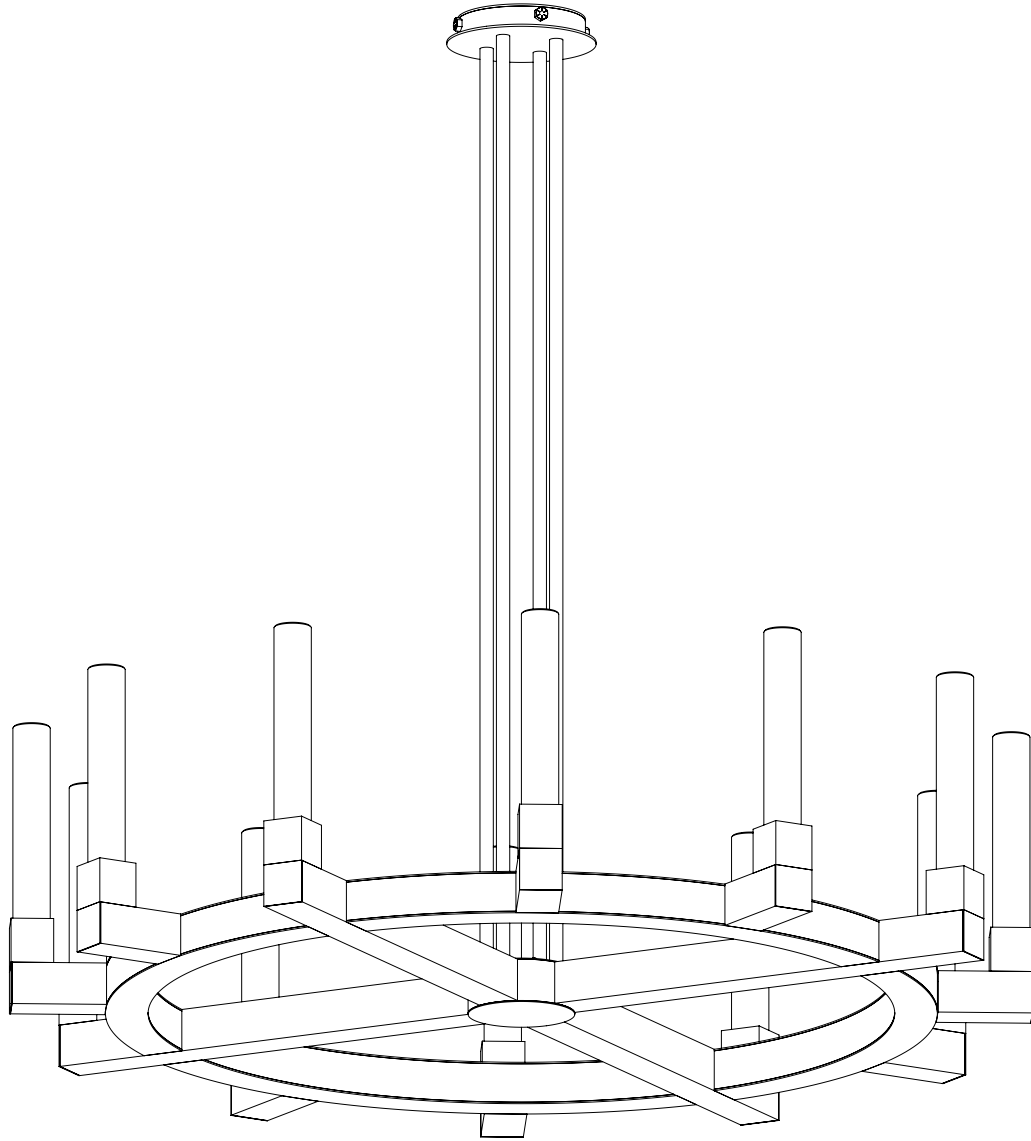

CSTA 0015 CH C

EXPLODED VIEW

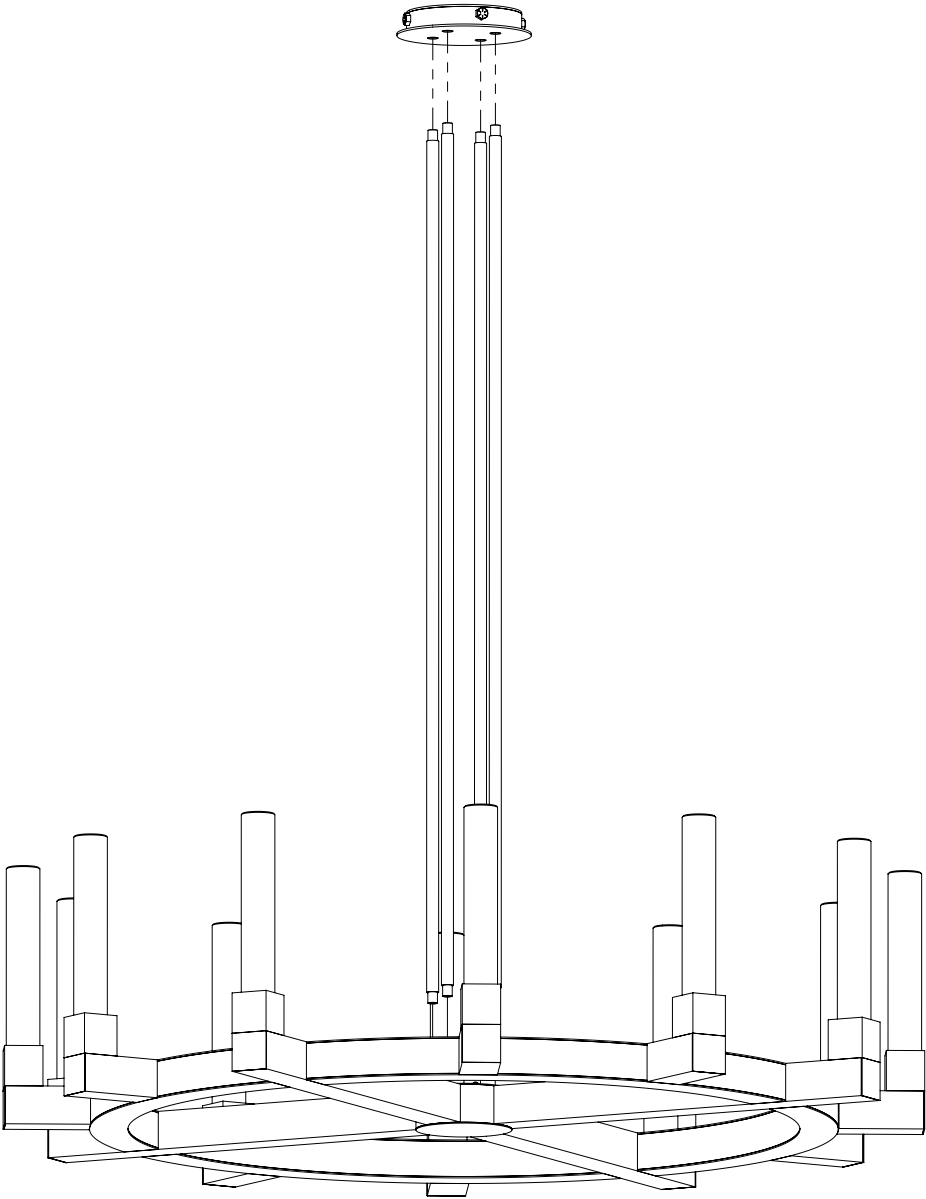

CSTA 0015 CH C